

# LIGHT : PSC

1

Istruzioni di montaggio:

Rev. 05

Cod.21056

08/07/2016

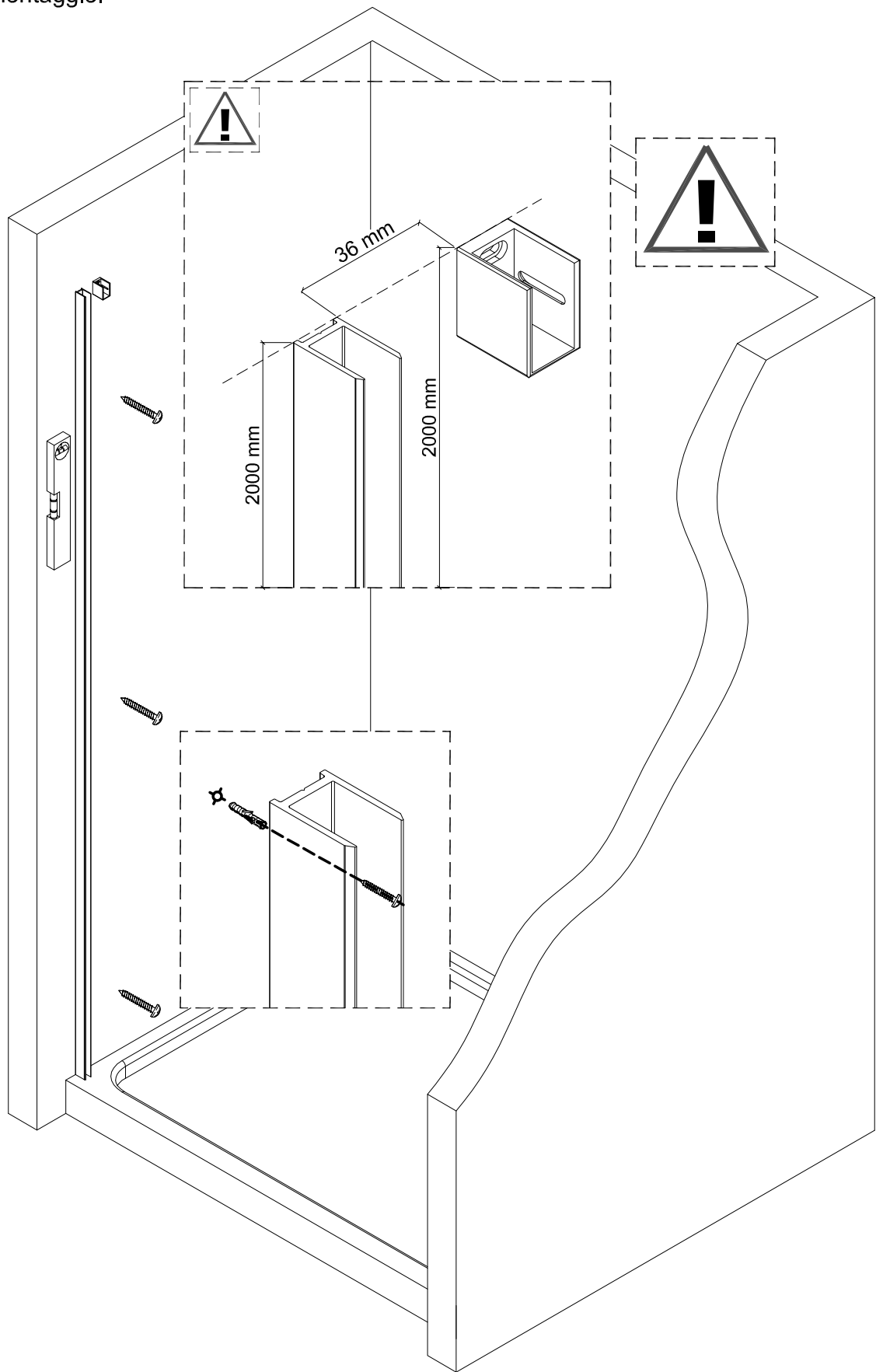

5 x



3.9X32

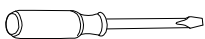

∅6

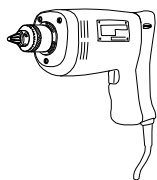

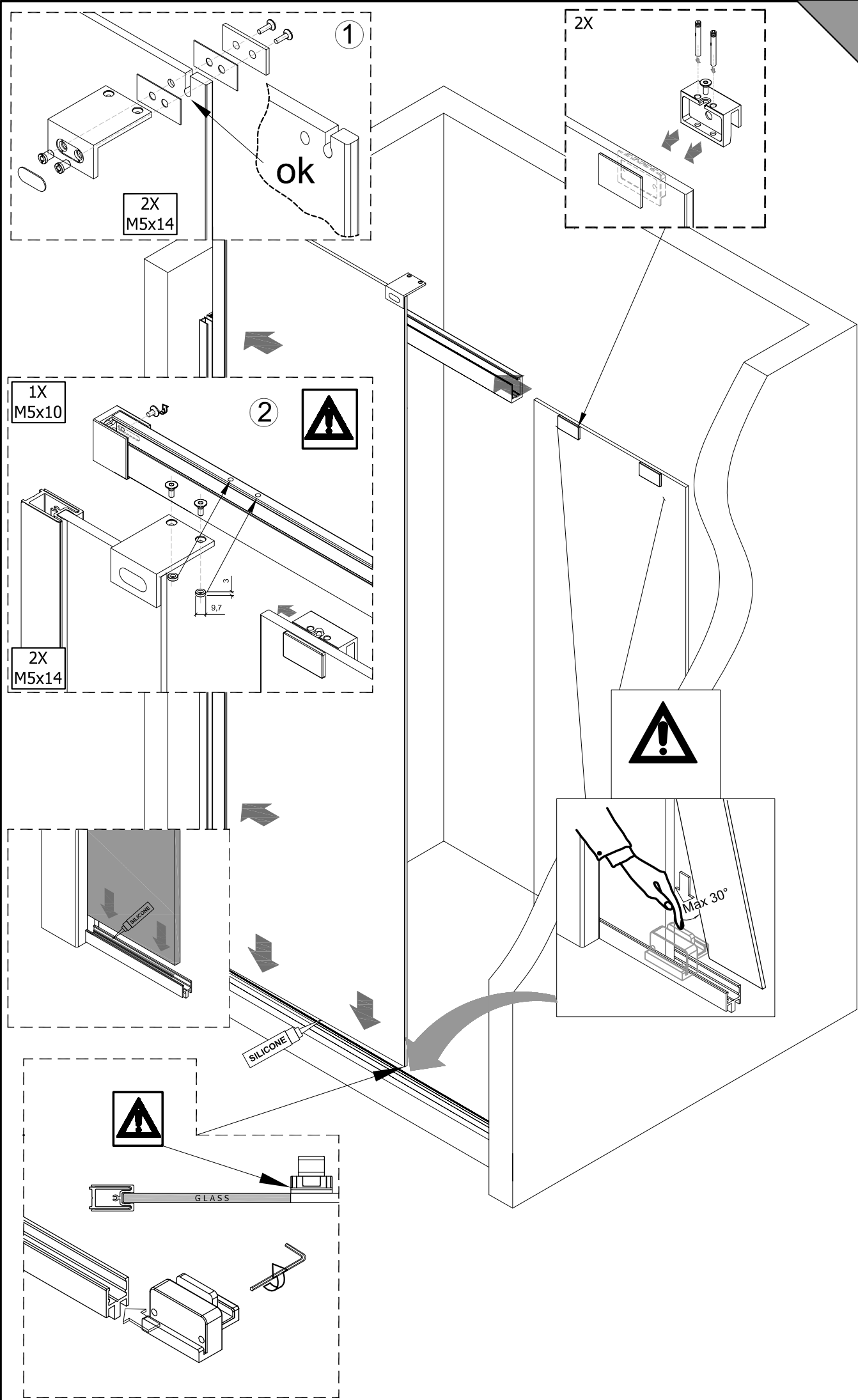

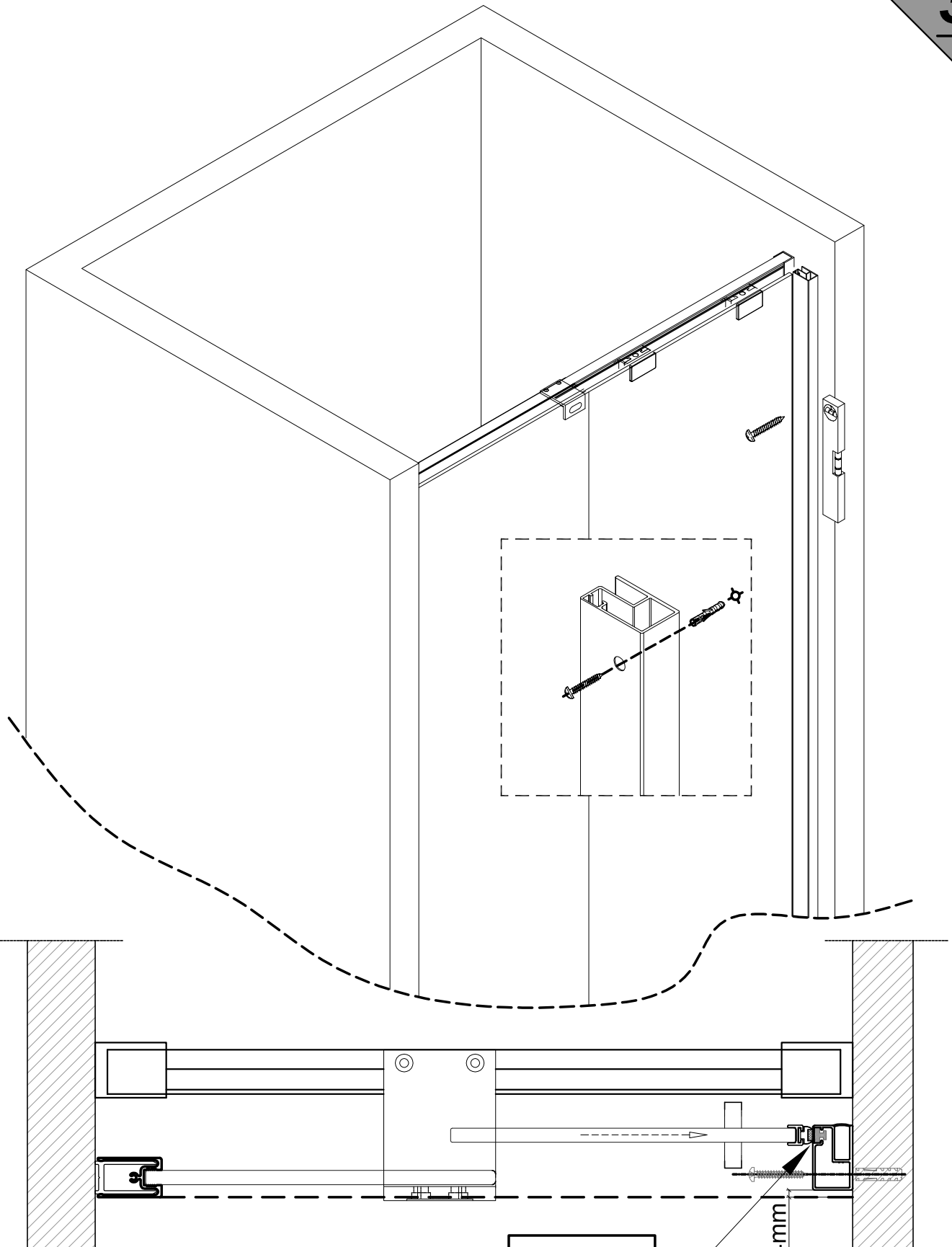

2 x

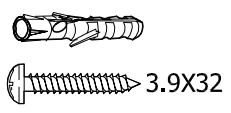

3.9X32

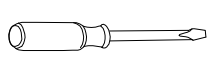

∅6

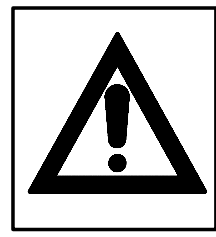
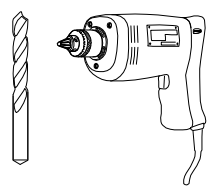

4mm

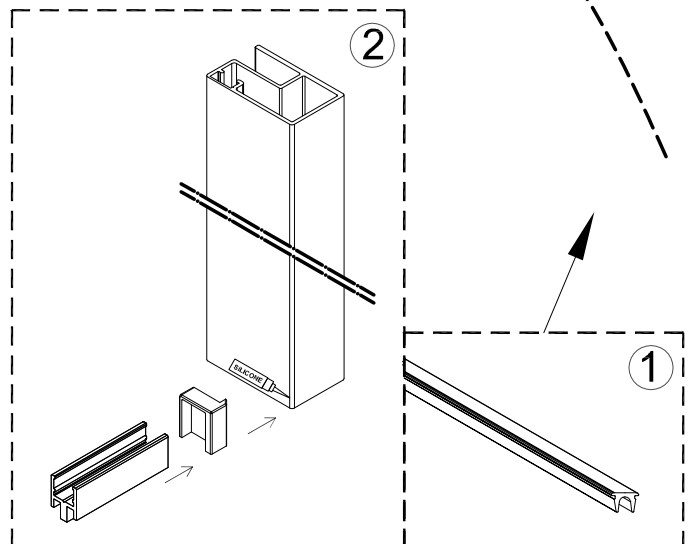
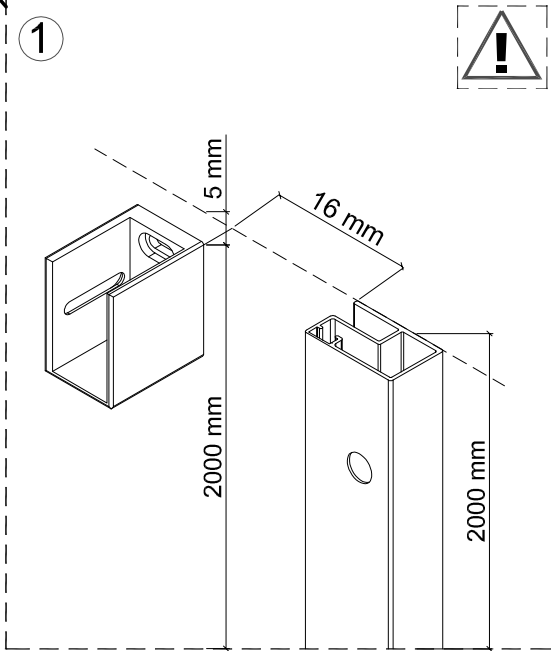
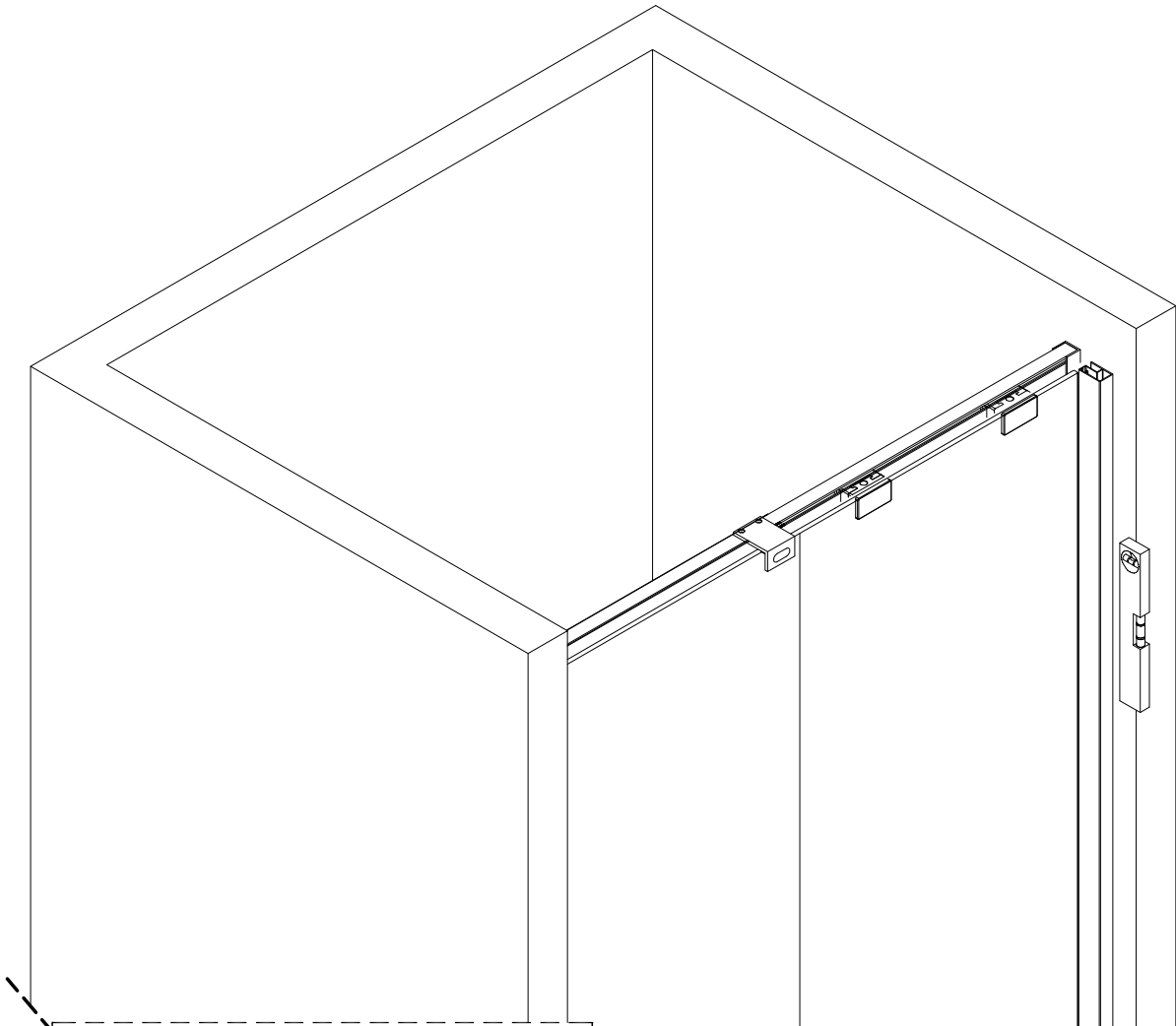

2 x

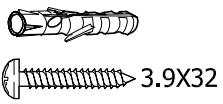

3.9X32

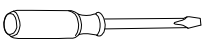

6

